

## DS8921/DS8921A/DS8921AT Differential Line Driver and Receiver Pair

### General Description

The DS8921, DS8921A are Differential Line Driver and Receiver pairs designed specifically for applications meeting the ST506, ST412 and ESDI Disk Drive Standards. In addition, these devices meet the requirements of the EIA Standard RS-422.

The DS8921, DS8921A receivers offer an input sensitivity of 200 mV over a  $\pm 7V$  common mode operating range. Hysteresis is incorporated (typically 70 mV) to improve noise margin for slowly changing input waveforms.

The DS8921, DS8921A drivers are designed to provide unipolar differential drive to twisted pair or parallel wire transmission lines. Complementary outputs are logically ANDed and provide an output skew of 0.5 ns (typ.) with propagation delays of 12 ns.

The DS8921, DS8921A are designed to be compatible with TTL and CMOS.

### Features

- 12 ns typical propagation delay
- Output skew - 0.5 ns typical
- Meet the requirements of EIA Standard RS-422
- Complementary Driver Outputs
- High differential or common-mode input voltage ranges of  $\pm 7V$
- $\pm 0.2V$  receiver sensitivity over the input voltage range
- Receiver input hysteresis-70 mV typical
- DS8921AT industrial temperature operation: ( $-40^{\circ}C$  to  $+85^{\circ}C$ )

### Connection Diagram

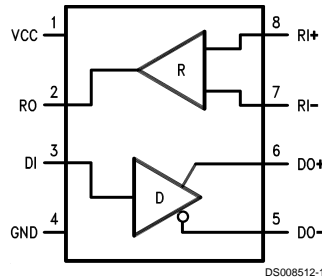

DS008512-1

Order Number DS8921M, DS8921N, DS8921AM, DS8921AN,  
DS8921ATM, or DS8921ATN  
See NS Package Number M08A or N08E

### Truth Table

Receiver		Driver		
Input	$V_{OUT}$	Input	$V_{OUT}$	$\overline{V_{OUT}}$
$V_{ID} \geq V_{TH} (MAX)$	1	1	1	0
$V_{ID} \leq V_{TH} (MIN)$	0	0	0	1
Open	1			

### Absolute Maximum Ratings (Note 1)

If Military/Aerospace specified devices are required, please contact the National Semiconductor Sales Office/Distributors for availability and specifications.

Supply Voltage	7V
Driver Input Voltage	-0.5V to +7V
Output Voltage	5.5V
Receiver Output Sink Current	50 mA
Receiver Input Voltage	±10V
Differential Input Voltage	±12V
Maximum Package Power Dissipation @ +25°C	
M Package	730 mW
N Package	1160 mW
Derate M Package	9.3 mW/°C above +25°C
Derate N Package	5.8 mW/°C above +25°C

Storage Temperature Range	-65°C to +165°C
Lead Temperature (Soldering, 4 sec.)	+260°C
Maximum Junction Temperature	+150°C

### Recommended Operating Conditions

	Min	Max	Units
Supply Voltage	4.5	5.5	V
Temperature (T <sub>A</sub> )			
DS8921/DS8921A	0	70	°C
DS8921AT	-40	+85	°C

### DS8921/DS8921A Electrical Characteristics (Notes 2, 3, 4)

Symbol	Conditions	Min	Typ	Max	Units
<b>RECEIVER</b>					
V <sub>TH</sub>	-7V ≤ V <sub>CM</sub> ≤ +7V	-200	±35	+200	mV
V <sub>HYST</sub>	-7V ≤ V <sub>CM</sub> ≤ +7V	15	70		mV
R <sub>IN</sub>	V <sub>IN</sub> = -7V, +7V (Other Input = GND)	4.0	6.0		kΩ
I <sub>IN</sub>	V <sub>IN</sub> = 10V			3.25	mA
	V <sub>IN</sub> = -10V			-3.25	mA
V <sub>OH</sub>	I <sub>OH</sub> = -400 μA	2.5			V
V <sub>OL</sub>	I <sub>OL</sub> = 8 mA			0.5	V
I <sub>SC</sub>	V <sub>CC</sub> = MAX, V <sub>OUT</sub> = 0V	-15		-100	mA
<b>DRIVER</b>					
V <sub>IH</sub>		2.0			V
V <sub>IL</sub>				0.8	V
I <sub>IL</sub>	V <sub>CC</sub> = MAX, V <sub>IN</sub> = 0.4V		-40	-200	μA
I <sub>IH</sub>	V <sub>CC</sub> = MAX, V <sub>IN</sub> = 2.7V			20	μA
I <sub>I</sub>	V <sub>CC</sub> = MAX, V <sub>IN</sub> = 7.0V			100	μA
V <sub>CL</sub>	V <sub>CC</sub> = MIN, I <sub>IN</sub> = -18 mA			-1.5	V
V <sub>OH</sub>	V <sub>CC</sub> = MIN, I <sub>OH</sub> = -20 mA	2.5			V
V <sub>OL</sub>	V <sub>CC</sub> = MIN, I <sub>OL</sub> = +20 mA			0.5	V
I <sub>OFF</sub>	V <sub>CC</sub> = 0V, V <sub>OUT</sub> = 5.5V			100	μA
V <sub>T</sub>   -  V <sub>T</sub> '				0.4	V
V <sub>T</sub>		2.0			V
V <sub>OS</sub> - V <sub>OS</sub> '				0.4	V
I <sub>SC</sub>	V <sub>CC</sub> = MAX, V <sub>OUT</sub> = 0V	-30		-150	mA
<b>DRIVER and RECEIVER</b>					
I <sub>CC</sub>	V <sub>CC</sub> = MAX, V <sub>OUT</sub> = Logic 0			35	mA

## Receiver Switching Characteristics

Figure 1(Figure 2)

Symbol	Conditions	Min	Typ	Max			Units
				8921	8921A	8921AT	
T <sub>pLH</sub>	C <sub>L</sub> = 30 pF (Figures 1, 2)		14	22.5	20	20	ns
T <sub>pHL</sub>	C <sub>L</sub> = 30 pF (Figures 1, 2)		14	22.5	20	20	ns
T <sub>pLH</sub> -T <sub>pHL</sub>	C <sub>L</sub> = 30 pF (Figures 1, 2)		0.5	5	3.5	5	ns

## Driver Switching Characteristics

SINGLE ENDED CHARACTERISTICS (Figures 3, 4)

Symbol	Conditions	Min	Typ	Max			Units
				8921	8921A	8921AT	
T <sub>pLH</sub>	C <sub>L</sub> = 30 pF (Figures 3, 4)		10	15	15	15	ns
T <sub>pHL</sub>	C <sub>L</sub> = 30 pF (Figures 3, 4)		10	15	15	15	ns
T <sub>TLH</sub>	C <sub>L</sub> = 30 pF (Figures 7, 8)		5	8	8	9.5	ns
T <sub>THL</sub>	C <sub>L</sub> = 30 pF (Figures 7, 8)		5	8	8	9.5	ns
Skew	CL = 30 pF (Figures 3, 4)		1	5	3.5	3.5	ns

## Driver Switching Characteristics (Note 6)

DIFFERENTIAL CHARACTERISTICS (Figures 3, 5)

Symbol	Conditions	Min	Typ	Max			Units
				8921	8921A	8921AT	
T <sub>pLH</sub>	C <sub>L</sub> = 30 pF (Figures 3, 5, 6)		10	15	15	15	ns
T <sub>pHL</sub>	C <sub>L</sub> = 30 pF (Figures 3, 5, 6)		10	15	15	15	ns
T <sub>pLH</sub> -T <sub>pHL</sub>	C <sub>L</sub> = 30 pF (Figures 3, 5, 6)		0.5	6	2.75	2.75	ns

**Note 1:** "Absolute Maximum Ratings" are those values beyond which the safety of the device cannot be guaranteed. They are not meant to imply that the device should be operated at these limits. The Table of "Electrical Characteristics" provides conditions for actual device operation.

**Note 2:** All currents into device pins are shown as positive values; all currents out of the device are shown as negative; all voltages are referenced to ground unless otherwise specified. All values shown as max or min are classified on absolute value basis.

**Note 3:** All typical values are V<sub>CC</sub> = 5V, T<sub>A</sub> = 25°C.

**Note 4:** Only one output at a time should be shorted.

**Note 5:** Difference between complementary outputs at the 50% point.

**Note 6:** Differential Delays are defined as calculated results from single ended rise and fall time measurements. This approach in establishing AC performance specifications has been taken due to limitations of available Automatic Test Equipment (ATE).

The calculated ATE results assume a linear transition between measurement points and are a result of the following equations:

$$T_{cr} = \frac{(T_{fb} \times T_{rb}) - (T_{ra} \times T_{fa})}{T_{rb} - T_{ra} - T_{fa} + T_{fb}}$$

Where: T<sub>cr</sub> = Crossing Point

T<sub>ra</sub>, T<sub>rb</sub>, T<sub>fa</sub> and T<sub>fb</sub> are time measurements with respect to the input. See Figure 6 .

## AC Test Circuits and Switching Diagrams

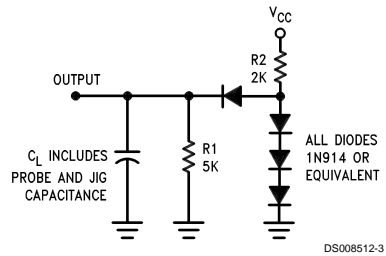

FIGURE 1.

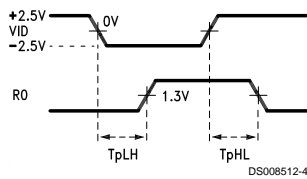

FIGURE 2.

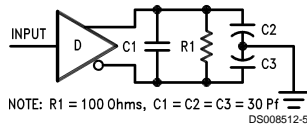

FIGURE 3.

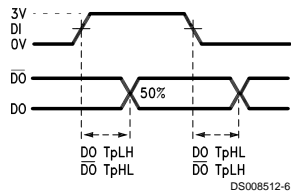

FIGURE 4.

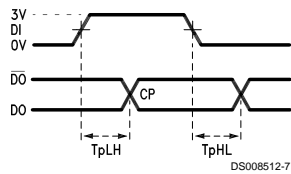

FIGURE 5.

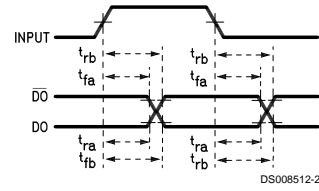

FIGURE 6.

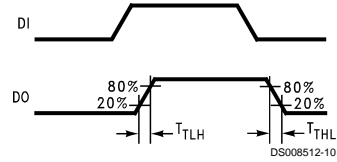

FIGURE 7.

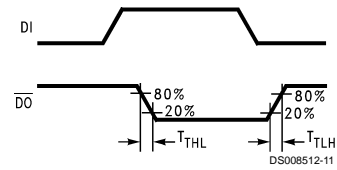
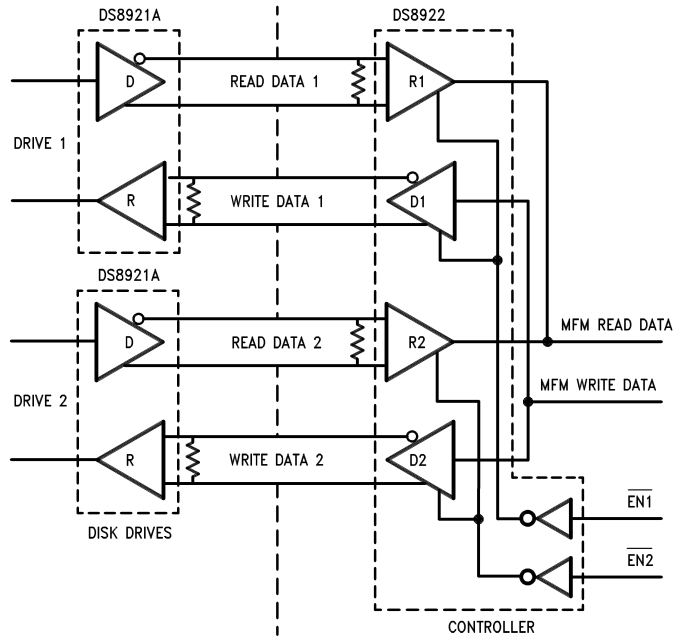

FIGURE 8.

# Typical Applications

## ST506 and ST412 Application



## ESDI Application

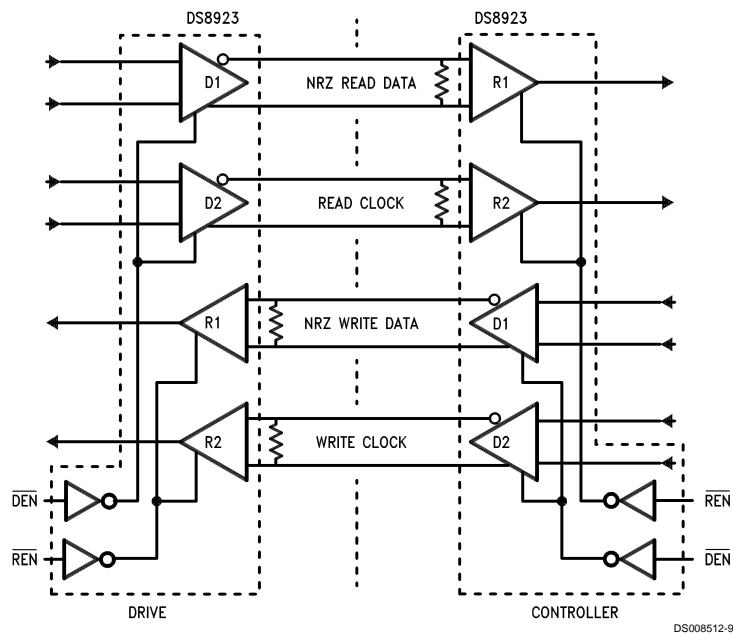



**Physical Dimensions** inches (millimeters) unless otherwise noted

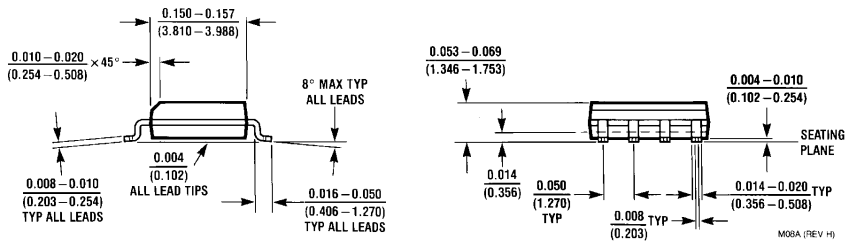
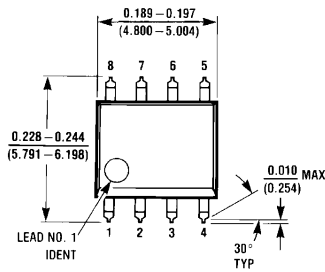

**SO Package (M)**  
**Order Number DS8921M, DS8921AM or DS8921ATM**  
**NS Package Number M08A**

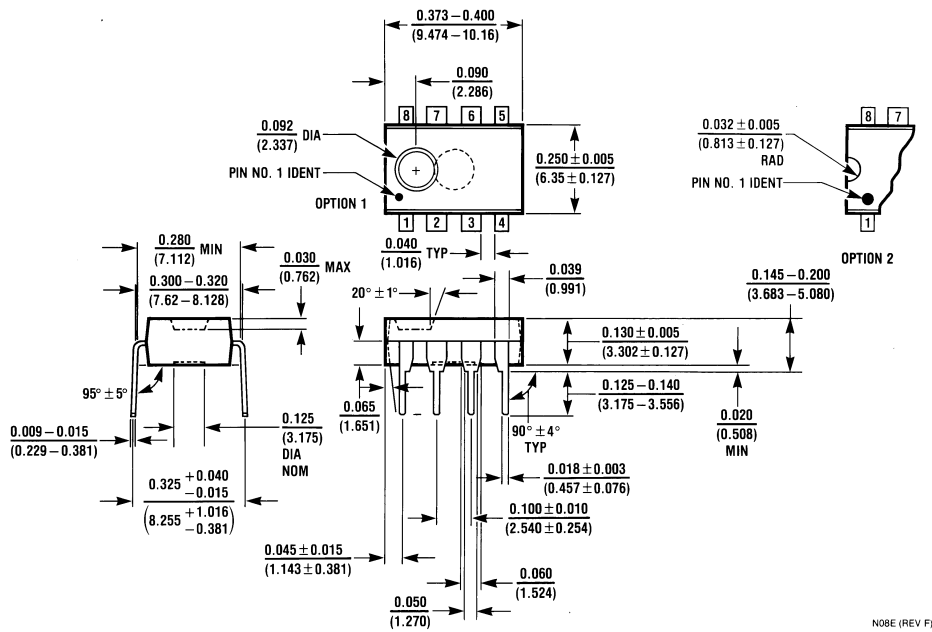

**Molded Dual-In-Line Package (N)**  
**Order Number DS8921N, DS8921AN or DS8921ATN**  
**NS Package Number N08E**

**LIFE SUPPORT POLICY**

NATIONAL'S PRODUCTS ARE NOT AUTHORIZED FOR USE AS CRITICAL COMPONENTS IN LIFE SUPPORT DEVICES OR SYSTEMS WITHOUT THE EXPRESS WRITTEN APPROVAL OF THE PRESIDENT OF NATIONAL SEMICONDUCTOR CORPORATION. As used herein:

1. Life support devices or systems are devices or systems which, (a) are intended for surgical implant into the body, or (b) support or sustain life, and whose failure to perform when properly used in accordance with instructions for use provided in the labeling, can be reasonably expected to result in a significant injury to the user.
2. A critical component in any component of a life support device or system whose failure to perform can be reasonably expected to cause the failure of the life support device or system, or to affect its safety or effectiveness.



**National Semiconductor Corporation**  
Americas  
Tel: 1-800-272-9959  
Fax: 1-800-737-7018  
Email: support@nsc.com

[www.national.com](http://www.national.com)

**National Semiconductor Europe**  
Fax: +49 (0) 1 80-530 85 86  
Email: europe.support@nsc.com  
Deutsch Tel: +49 (0) 1 80-530 85 85  
English Tel: +49 (0) 1 80-532 78 32  
Français Tel: +49 (0) 1 80-532 93 58  
Italiano Tel: +49 (0) 1 80-534 16 80

**National Semiconductor Asia Pacific Customer Response Group**  
Tel: 65-2544466  
Fax: 65-2504466  
Email: sea.support@nsc.com

**National Semiconductor Japan Ltd.**  
Tel: 81-3-5620-6175  
Fax: 81-3-5620-6179